



**BY-PM700**  
USB Microphone  
Instruction Manual

### Introduction

Thanks for choosing BOYA!

The BOYA BY-PM700 is a USB condenser microphone, and compatible with Windows and Mac Computers. Its polar pattern knob lets you opt for omni-directional, Cardioid, Stereo and bi-directional pickup modes, suit for various situations, such as recording, interviews, conference calls, vocals, instruments, podcasting and more.

This mic can capture your audio in up to 16 bit/48 kHz resolution, and it features gain control, mute button, zero-latency headphone output.

This mic has durable all metal construction, includes desk stand that can adjust microphone in various desired angles, also functionality of folding the mic down for storage and transport as well.

### Package Contents

- BY-PM700 Microphone
- USB Cable
- User Manual

### Instructure

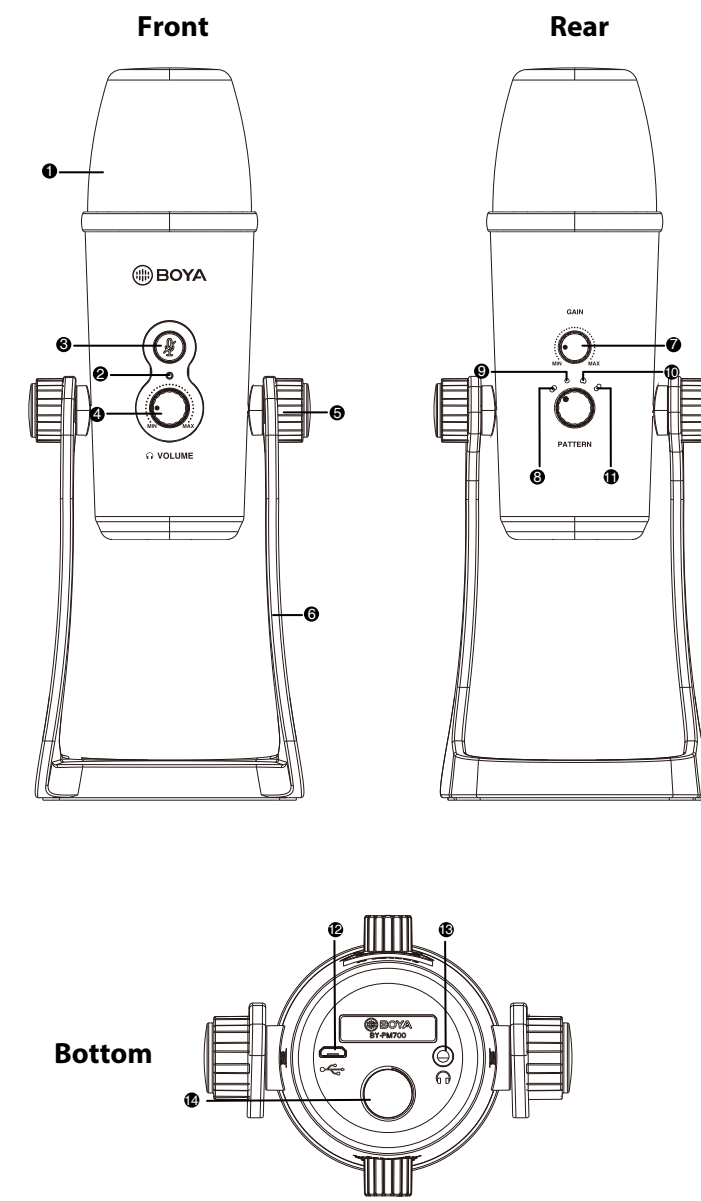

### Introduction

1. Tri-Capsule Array
2. Power Indicator
3. Mute Button  
Press mute button, when LED indicator is red, muting function on.

4. Headphone Volume Control
5. Screws
6. Desk Stand
7. Microphone Gain

8. Stereo Pattern  
Pick up the sound from left and right side, it is ideal for capturing a realistic, general sound.

9. Cardioid Pattern  
Maximizes the rejection of sound coming from the sides and rear of the mic and can be used as a directional microphone to capture full, rich, natural-sounding audio for podcast, speech, dialog, instrument etc.

10. Omnidirectional Pattern  
Pick up sound equally from all directions, capturing a natural blend of voice and ambiance with low sensitivity to wind and handling noise, as well as to vocal plosives.

11. Bi-directional Pattern  
Pick up sound at the front and rear of the microphone, while sounds to the sides are not picked up, it fits for capturing instruments, or recording an interview between two people.

12. Mini USB Connection
13. Headphone Output
14. 5/8" screw

### Features:

- Compatible with Windows and Mac Computers
- Triple-capsule design
- Stereo, cardioid, omnidirectional, and bi-directional polar patterns
- 16 Bit/48 kHz Resolution
- Muting function
- 1/8" Headphone Monitoring Jack
- Latency-Free Monitoring
- Desktop Stand
- Durable all metal construction
- Intergrated USB cable

### Specifications:

Diaphragm:	14 mm(0.55")
Frequency Response :	20-20,000Hz
Sensitivity :	-45dB±3dB@1KHz
Power Consumption:	5V/150mA
Sample Rate:	48 kHz
Bit Depth:	16 Bit
Headphone Amplifier:	Impedance: 16ohms
	Power output(RMS): 130mW
Plug:	Frequency Response: 15-20,000Hz
	Micro USB
Size:	112 x 108 x 200mm(4.4 x 3.8 x 7.9")(Min.)
	112 x 108 x 295mm(4.4 x 3.8 x 11.6") (Max.)
Weight:	1042g(36.8oz)

### How to use

1. Unscrew the knobs of both sides at anti-clockwise.
2. Adjust the microphone at your desired angle, then screw the knobs of both sides at anti-clockwise to fix the microphone.
3. Plug the mini USB of supplied cable into the USB port of microphone, and connect the other plug into the available USB port of your computer.
4. Connect your headphone to 3.5mm headphone output if needed.

### Set Up for Windows 10

1. Connect microphone with a USB port on your computer using the supplied USB cable.
2. Go to "Setting", choose "Sound" as shown below.
3. Select "Speaker BY-PM700" as Output device.
4. Select "Microphone BY-PM700" as Input device.

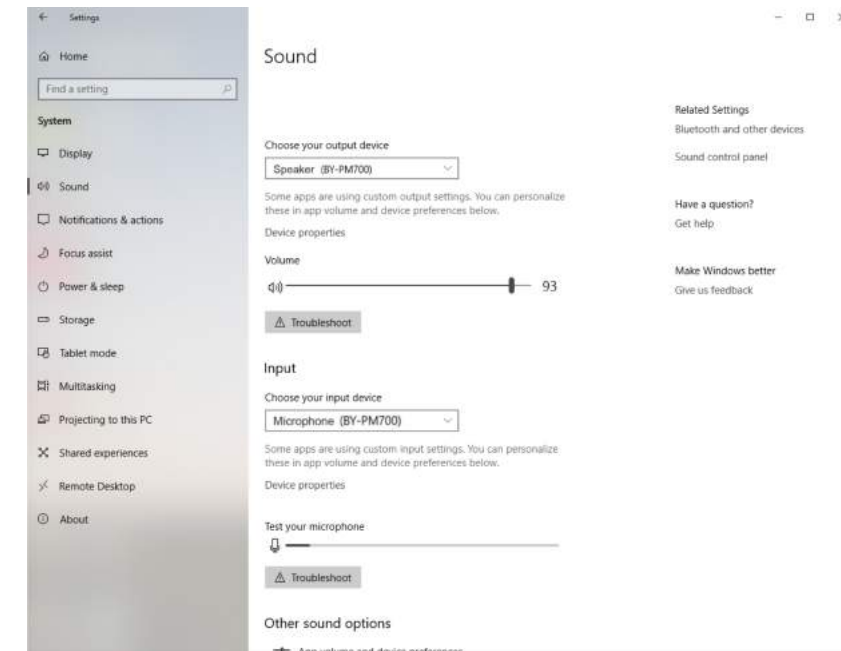

### Set Up for Windows 8

1. Connect microphone with a USB port on your computer using the supplied USB cable.
2. From the "Setting Menu", select the "Control Panel".
3. Go to "Control Panel", select "Hardware and Sound"



4. Select "Sound"

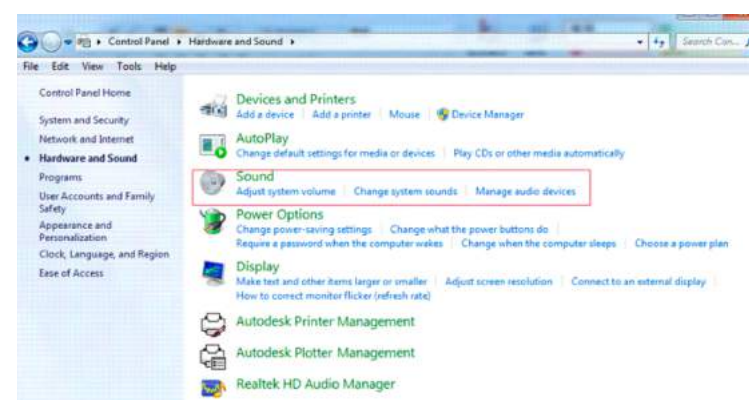

5. Select "Speaker BY-PM700" as the default device in the "Sound", under "Playback" manu.

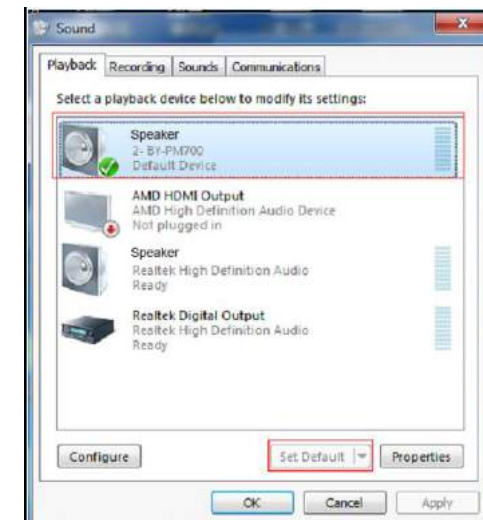

6. Select "Microphone BY-PM700" as the default device in the "Sound", under "Recording" manu.

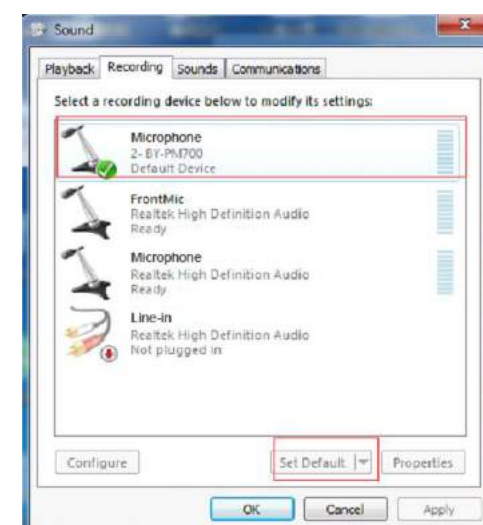

### Setup for Apple System

1. Connect the BOYA BY-PM700 to an un-used USB port on your computer.
2. Go to Apple Icon-->System Preferences-->Sound Icon.



3. Select "BY-PM700" under "Input" tab.

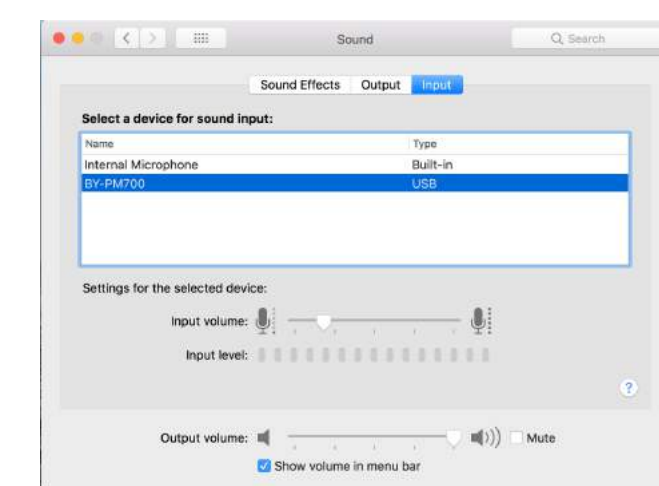

4. Select "BY-PM700" under "Output" tab.

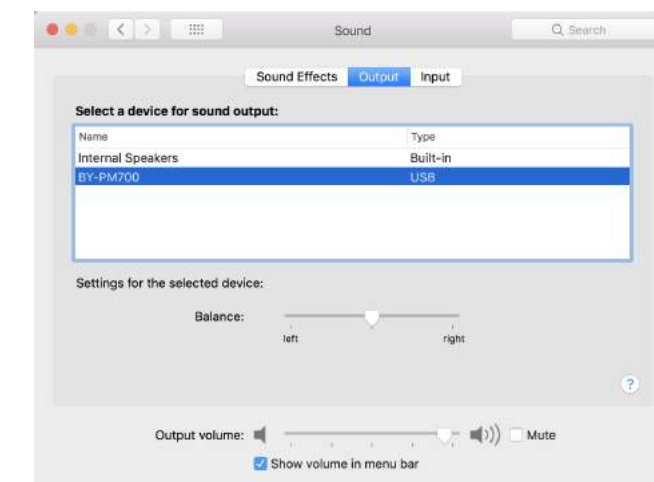

### IMPORTANT

- If you do not intend to use the conference microphone for a long period time, please remove the USB cable.
- Do not touch the microphone while recording, as this will cause noise to be recorded.
- Do not let the microphone close to high-voltage equipment or to devices that emit strong electromagnetic fields, otherwise, it may cause the noise to be recorded.
- Do not use or leave the microphone in hot, humid places.

### MAINTENANCE

- Do not operate the device with wet hands or feet.
- Clean the equipment only in the way described in the instructions for use.

www.boyam-mic.com

SHENZHEN JIAYZ PHOTO INDUSTRIAL., LTD.  
The BOYA logo is a trademark which is registered and owned by Shenzhen Jiayz Photo Industrial., Ltd.  
COPY RIGHT 2010-2020  
Email: sales@boyam-mic.com  
www.boyam-mic.com / www.jiayz.com



# 深圳市长丰影像器材有限公司

产品/零件名称	BY-PM700 说明书	比例	1:1	版本	V00
工程图号	BY-PM700 说明书V00	物料描述	105g双铜纸 骑马钉 14p		
物料编号	1F14015BY0130	尺寸/用量	尺寸: 120x200mm	1/1PCS	
制图人/日期	吴蒙蒙/2018/10/9	审核/日期			